

SPECIFICATION
MODEL : SPHWWTHDD805WHW0DD



[Approved Rank : $V_F(WH)$,
CCT(WW, WX, WY, WZ), $I_{mV}(DB, FB)$]

HV-DC WA6 LED

CUSTOMER :		
DRAWN	CHECKED	APPROVED

SAMSUNG LED		
DRAWN	CHECKED	APPROVED

PRELIMINARY

SAMSUNG LED CO.,LTD.
314. MAETAN3-DONG, YEONGTONG-KU,
SUWON-SI,GYUNGKI-DO,KOREA,442-743

Contents

1. Product Outline	-----	3
2. Absolute Maximum Rating	-----	3
3. Characteristics	-----	3
4. Typical Characteristics Graph	-----	6
5. Outline Drawing & Dimension	-----	8
6. Reliability Test Items & Conditions	-----	9
7. Label Structure	-----	10
8. Lot Number	-----	10
9. Tray Dimension	-----	11
10. Carton Box	-----	12
11. Aluminium Packing Bag	-----	14
12. Precaution For Use	-----	15
13. Revision History	-----	16

1. Product Outline

1) Features

- 8W HVDC LED : 25.25 x 20.25 x t 6.9 (mm)
- Wide Beam Angle ($\Delta\theta$: 134° x 134°) for uniform illuminance
- InGaN/GaN MQW LED with long-time reliability
- Lead (Pd) free product – RoHS compliant

2) Applications

- Substitution for Incandescent lamp
- Substitution for Fluorescent lamp
- Substitution for Signal lamp
- Other applications

2. Absolute Maximum Rating

- 1) Operation Forward Current ($T_a = 25^\circ\text{C}$) 620 mA
- 2) Flash Mode Peak Pulsed Forward Current 660 mA
(Pulse width $t \leq 10\text{msec}$, Duty ratio=0.06, $T_a=25^\circ\text{C}$)
- 3) Thermal Resistance ($R_{\text{th,j-s}}$) 2.24 $^\circ\text{C}/\text{W}$
- 4) LED Junction Temperature (T_J) 150 $^\circ\text{C}$
- 5) Operating Temperature Range (T_{opr}) -40 $^\circ\text{C}$ ~ 80 $^\circ\text{C}$
- 6) Storage Temperature Range (T_{stg}) -40 $^\circ\text{C}$ ~ 100 $^\circ\text{C}$

3. Characteristics

1) Electro-Optical characteristics

($T_a : 25^\circ\text{C}$)

Item	Unit	Condition	Rank	Min	Typ	Max	
Luminous Flux ²⁾	lm	$I_F = 460 \text{ mA}^{1)}$	DD	DB	650	-	750
				FB	750	-	850
Forward Voltage (V_F)	$V^{3)}$	$I_F = 460 \text{ mA}$	WH	17	-	18	
CCT	K	$I_F = 460 \text{ mA}$	-	-	2700 ⁴⁾	-	
CRI		$I_F = 460 \text{ mA}$	-	80	-	-	
View Angle ⁵⁾	$^\circ$	$I_F = 460 \text{ mA}$	-	-	134 $^\circ$	-	

Notes:

- 1) Samsung LED tested in pulsed condition. $T_J=25^\circ\text{C}$, pulse width is 10ms at rated test current.
- 2) Samsung LED has $\pm 10\%$ tolerance of flux measurements.
- 3) Samsung LED has $\pm 5\%$ tolerance of forward voltage measurements.
- 4) Samsung LED has $\pm 5\%$ tolerance of CCT measurements.
- 5) Samsung LED tested in DC=460mA after luminous flux is saturated.
- 6) Samsung LED has $\pm 0.15 \text{ mm}$ tolerance on device dimensions.

2) Electro-Optical characteristics

Power	If (mA)	Vf (V)	CCT	Flux (lm)	Lm/W	CRI
5W	310	17.2	CW(5000K)	665	133	70+
			WW(4000K)	575	115	80+
			WW(3000K)	520	104	80+
			WW(2700K)	505	101	80+
6W	360	17.3	CW(5000K)	780	130	70+
			WW(4000K)	672	112	80+
			WW(3000K)	612	102	80+
			WW(2700K)	594	99	80+
7W	410	17.4	CW(5000K)	896	128	70+
			WW(4000K)	770	110	80+
			WW(3000K)	700	100	80+
			WW(2700K)	679	97	80+
8W	460	17.6	CW(5000K)	1,000	125	70+
			WW(4000K)	864	108	80+
			WW(3000K)	784	98	80+
			WW(2700K)	760	95	80+
9W	510	17.75	CW(5000K)	1,107	123	70+
			WW(4000K)	954	106	80+
			WW(3000K)	864	96	80+
			WW(2700K)	837	93	80+
10W	560	17.9	CW(5000K)	1,200	120	70+
			WW(4000K)	1,040	104	80+
			WW(3000K)	940	94	80+
			WW(2700K)	910	91	80+
11W	620	18.05	CW(5000K)	1,298	118	70+
			WW(4000K)	1,122	102	80+
			WW(3000K)	1,012	92	80+
			WW(2700K)	979	89	80+

3) Chromaticity Diagram

 ($T_a : 25^{\circ}\text{C}$)

Table		W0	
		CIE X	CIE Y
2700K	WW	0.4465	0.4071
		0.4562	0.4260
		0.4687	0.4289
		0.4582	0.4099
		0.4465	0.4071
	WX	0.4373	0.3893
		0.4465	0.4071
		0.4582	0.4099
		0.4483	0.3919
		0.4373	0.3893
	WY	0.4582	0.4099
		0.4687	0.4289
		0.4813	0.4319
		0.4700	0.4126
		0.4582	0.4099
	WZ	0.4483	0.3919
		0.4582	0.4099
		0.4700	0.4126
		0.4593	0.3944
		0.4483	0.3919

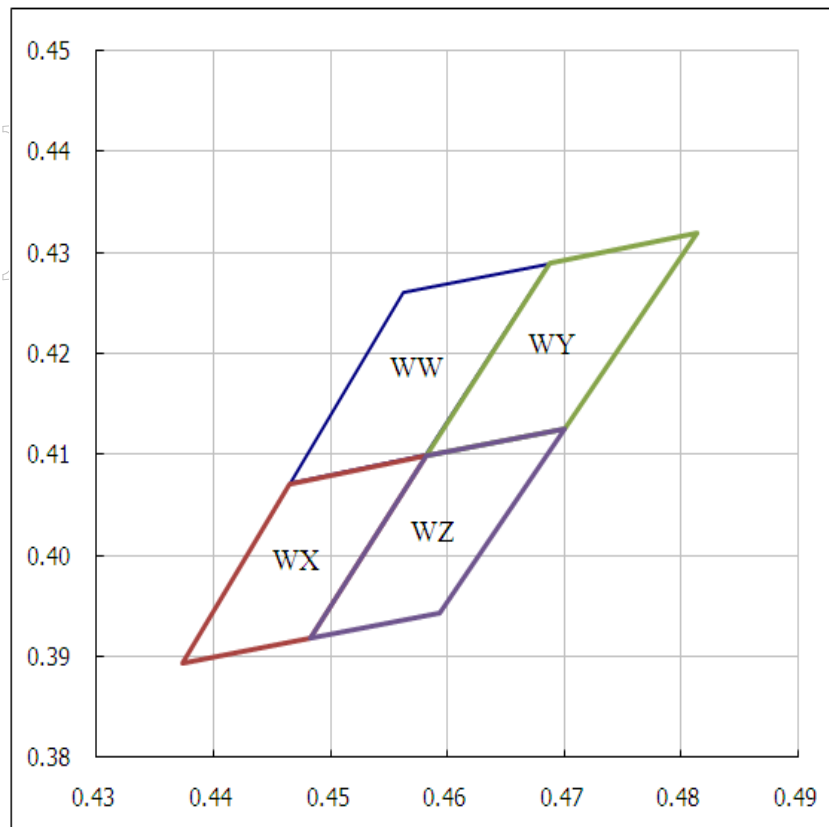

4. Typical Characteristics Graph

* These graphs show typical values.

Luminous Flux vs. Forward Current

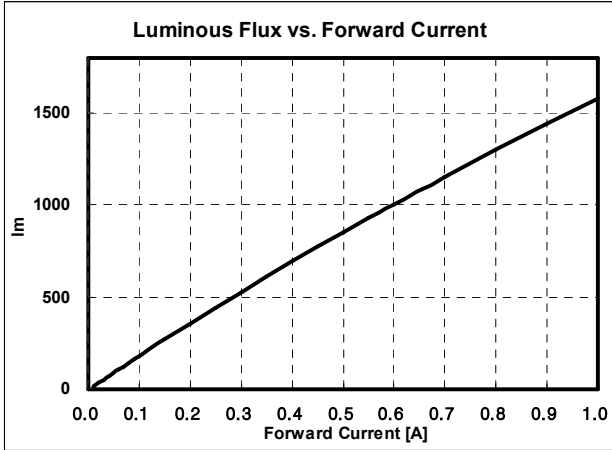

Forward Current vs. Forward Voltage

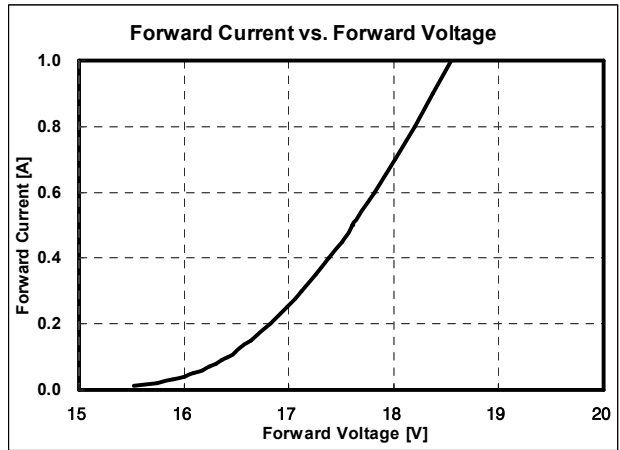

NOTE : Kiethley max current 1A (compliance 63v)

Radiation Pattern

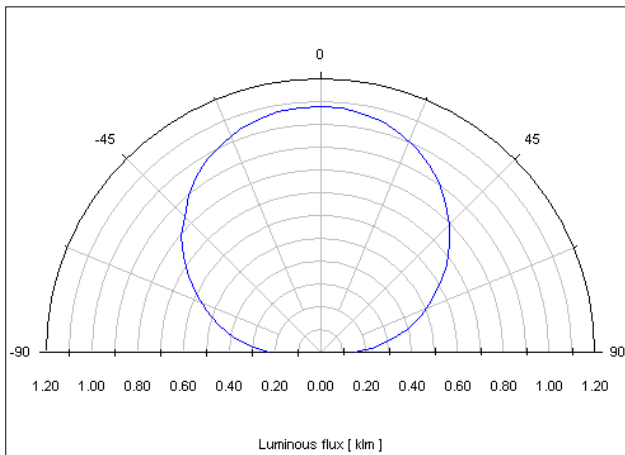

Color x,y vs. Forward current

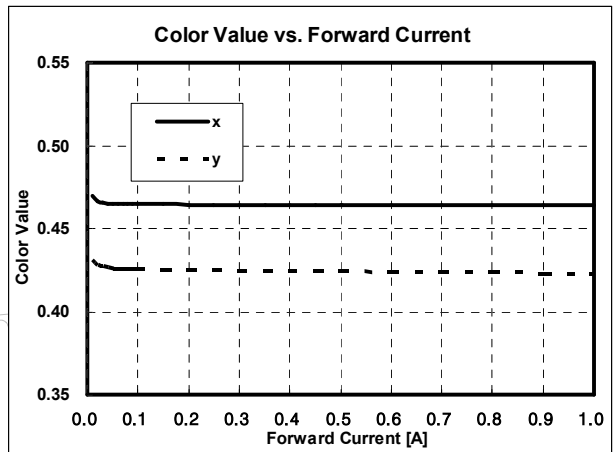

CCT vs. Forward current

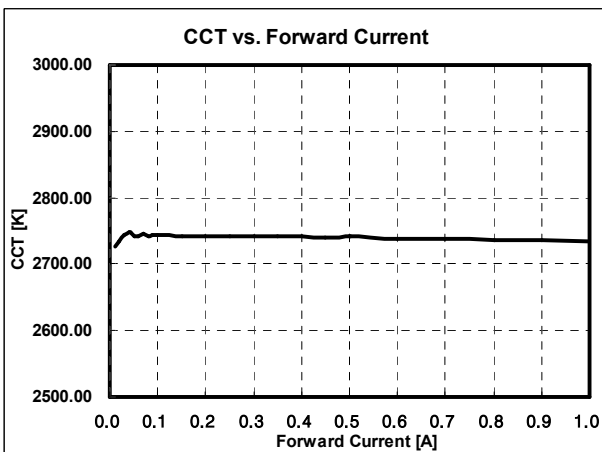

Relative Spectral Emission

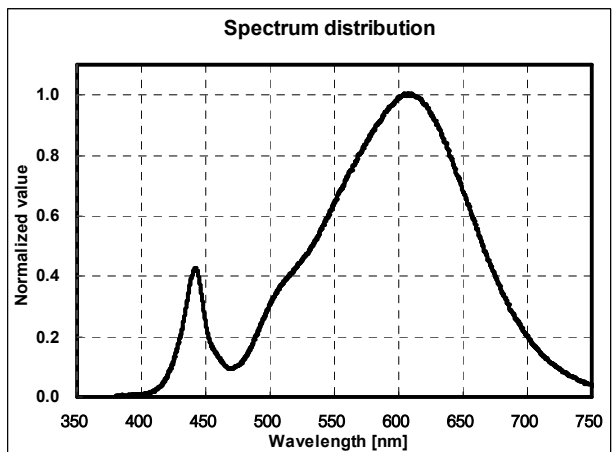

CCT vs. Temperature

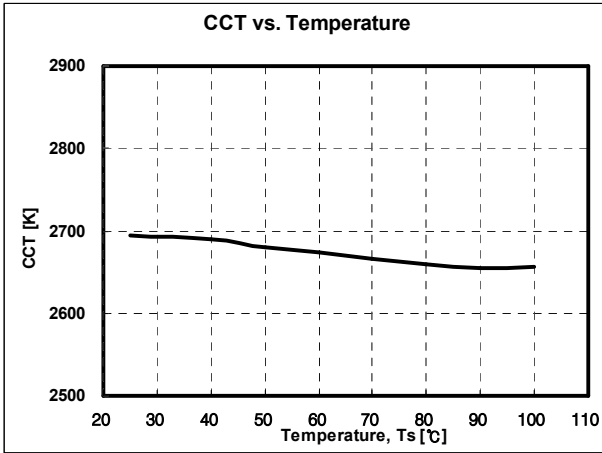

Voltage vs. Temperature

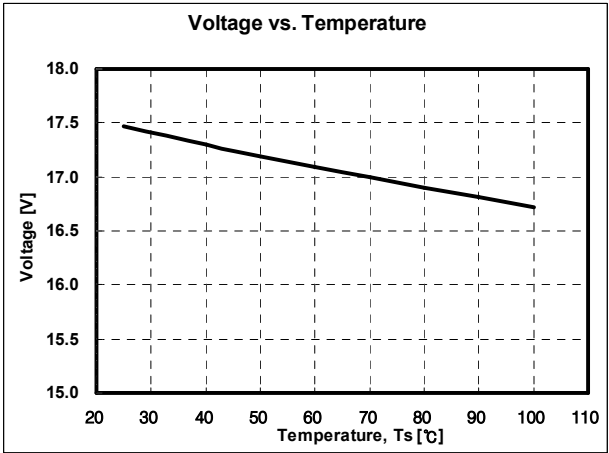

Relative Luminous Flux vs. Temperature

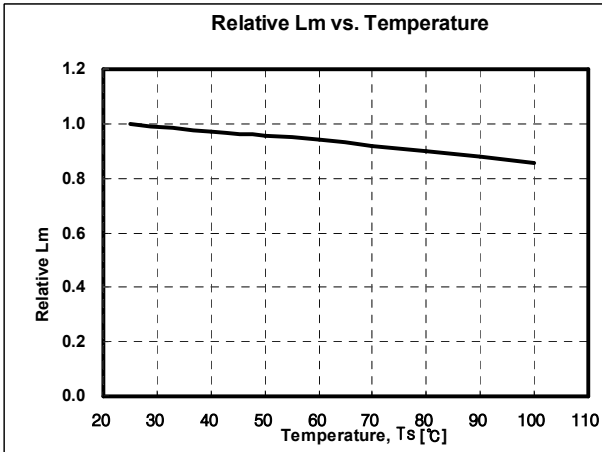

Derating curve

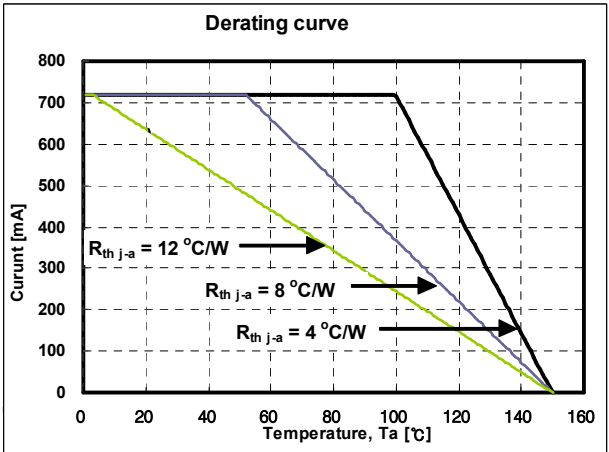

PRELIMINARY

(T_a = 25°C)

5. Outline Drawing & Dimension

unit : mm
Tolerance : ± 0.15

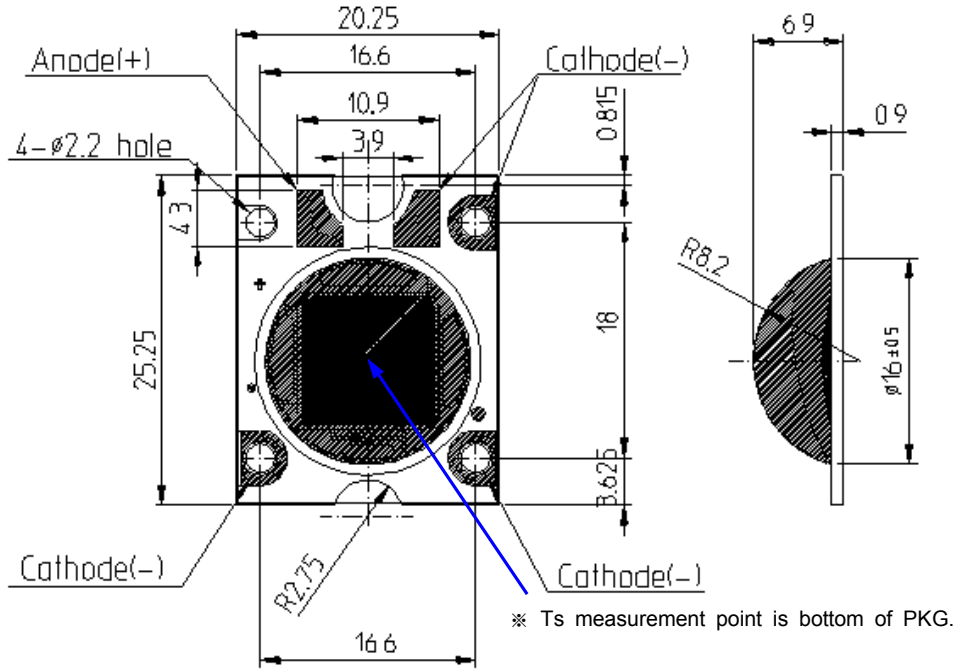

* This LED has built-in ESD protection device(s) connected in parallel to LED chip(s).

PRELIMINARY

6. Reliability Test Items and Conditions

1) Test Items

Test Items	Test Conditions	Test Hours/Cycles
Room Temperature life test	25°C, DC $I_F = \text{Max}$	1,000 h
High Temperature humidity life test	85°C, 85% RH, DC $T_j = \text{Max}$	1,000 h
High Temperature life test	85°C, DC $T_j = \text{Max}$	1,000 h
Low Temperature life test	-40°C, DC 460 mA	1,000 h
High Temperature Storage	120°C	1,000 h
Low Temperature Storage	-40°C	1,000 h
Thermal Shock	-40 / 120°C, each 30 min	200 cycles
Temperature humidity Cycle On/Off test	-40 / 85°C, each 20 min, 100 min transfer Power On/off each 5 min, DC 460 mA	100 cycles
Reflow (Pb-Free)	Peak 260±5°C for 10 sec	3 times
ESD(HBM)	R1 : 10 MΩ , R2 : 1.5 kΩ , C : 100 pF	5 times (± 2 kV)

2) Criteria for Failure

Item	Symbol	Test Condition [$T_a = 25^\circ\text{C}$]	Limit	
			Min.	Max.
Forward Voltage	V_F	460 mA	L.S.L. × 0.9	U.S.L. × 1.1
Luminous flux	I_m	460 mA	L.S.L. × 0.7	U.S.L. × 1.3

* U.S.L. : Upper Standard Level L.S.L. : Lower Standard Level

7. Label Structure

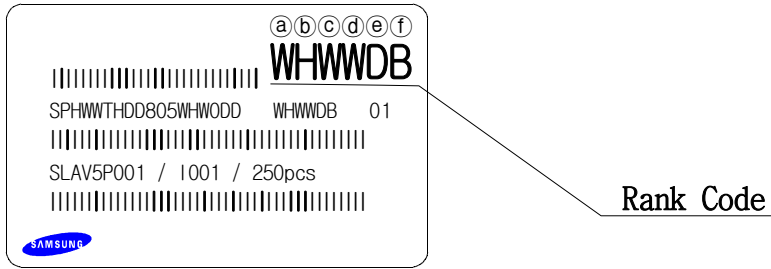

N.B) Denoted rank is the only example.

Rank Code

- ⒶⒷ : Forward Voltage (V_f) Rank (refer to page. 3)
- ⒸⒹ : Chromaticity Coordinate Rank (refer to page. 4)
- ⒺⒻ : Luminous Flux (Φ_v) Rank (refer to page. 3)

8. Lot Number

The Lot number is composed of the following characters

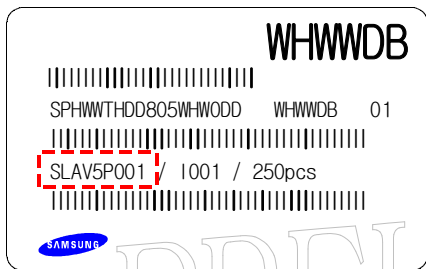

●◎◇◆□■△▲▲▲ / |▲▲▲▲ / 250PCS

- : Production Site (S:SAMSUNG LED Suwon, G:Gosin China, A:Aprosystems)
- ◎ : L (LED)
- ◇ : Product State (A:Normality, B: Bulk, C:First Production, R:reproduction, S:Sample)
- ◆ : Year (S:2008, T:2009, U:2010, V:2011...)
- : Month (1 ~ 9, A~C)
- : Day (1 ~ 9, A, B ~ V)
- △ : SAMSUNG LED Product number (1 ~ 999)
- ▲ : Tray Number (1 ~ 999)

9. Tray Dimension

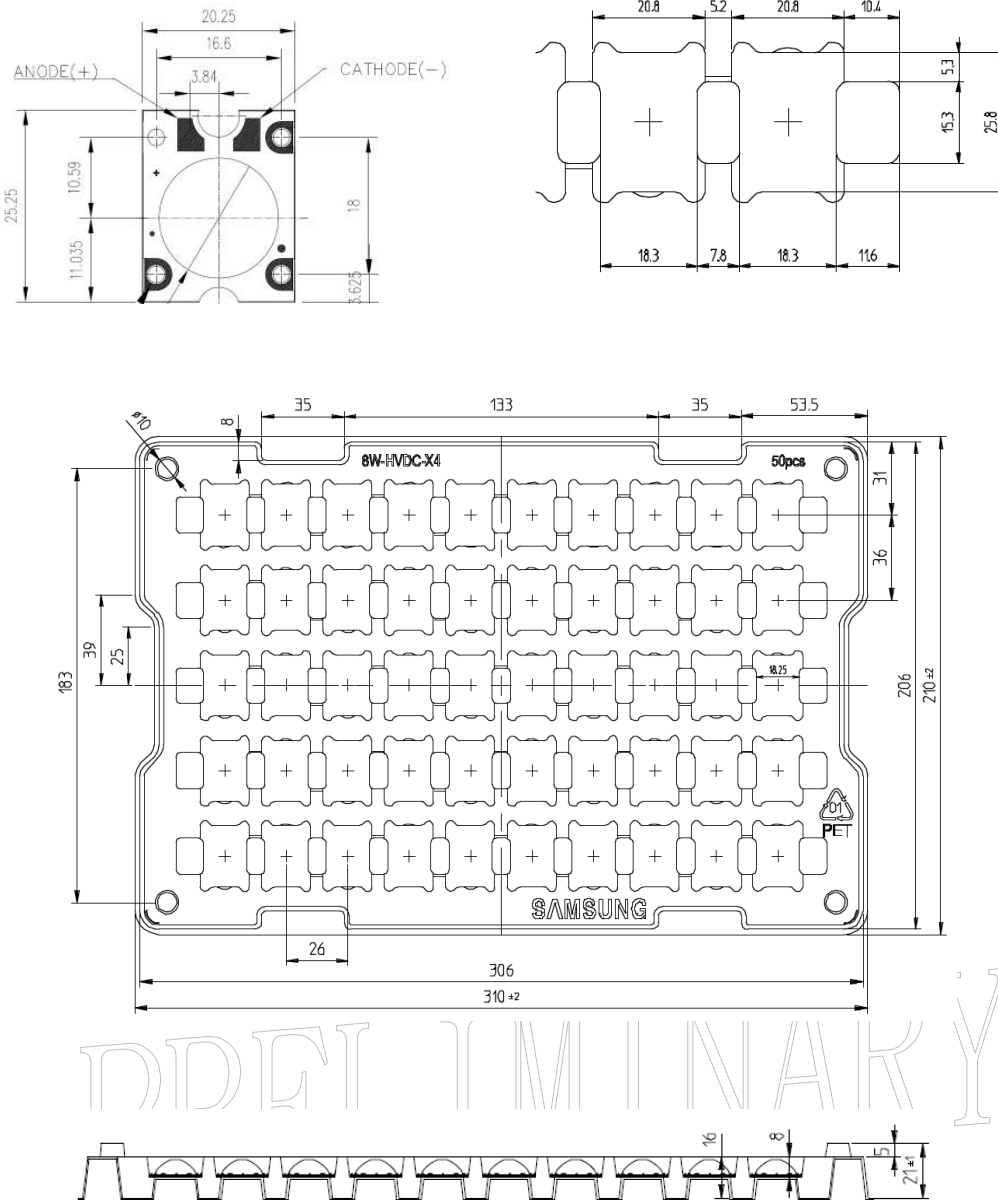

Symbol	L	W	H	L'	W'
Dimension(mm)	310 ± 2	210 ± 2	21 ± 1	25.8	20.8

- (1) Quantity : 50 Pcs / Tray
- (2) Cumulative Tolerance : Cumulative Tolerance/Tray is less than ± 2 mm
- (3) Adhesion Strength of Cover Tape : Adhesion strength to be 0.1-0.7N when the cover tape is turned off from the carrier tape at 10 °C angle to be the carrier tape.
- (4) Packaging : P/N, Manufacturing data Code No. and quantity to be indicated on a damp proof Package

10. Carton Box

TYPE	SIZE(mm)			Pack	Box
	(a)	(b)	(c)	Amount	
13inch	333	231	155	250pcs	500pcs

*** 50pcs**

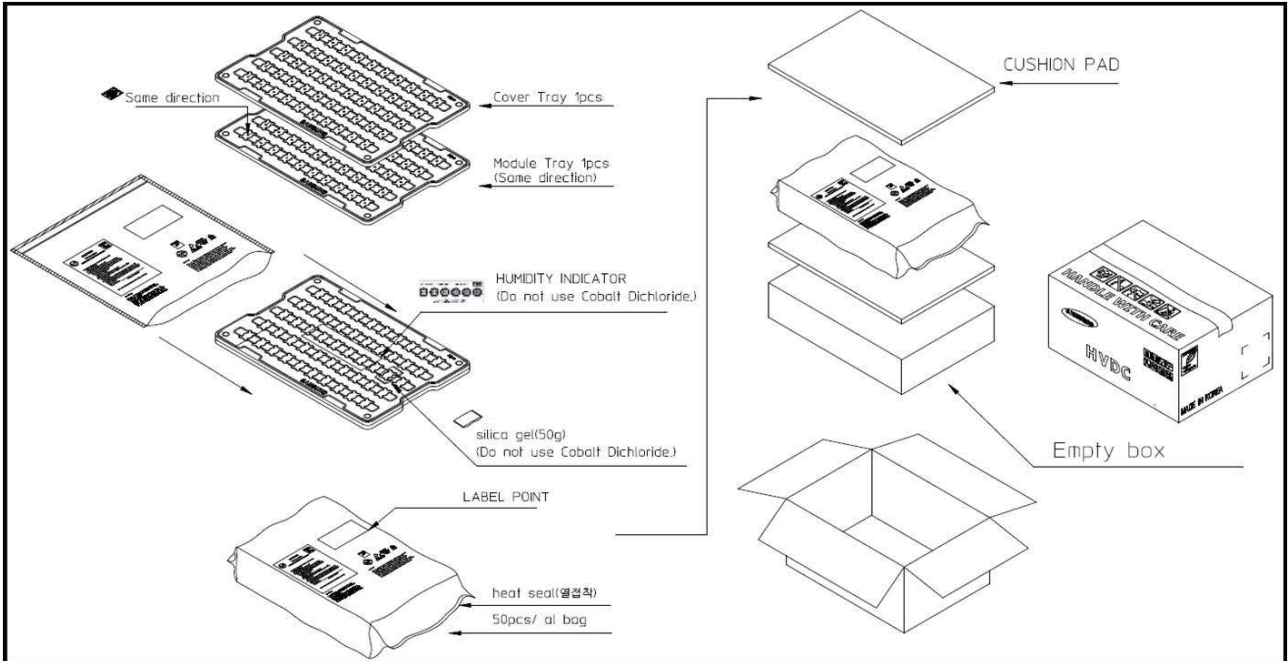

*** 250pcs**

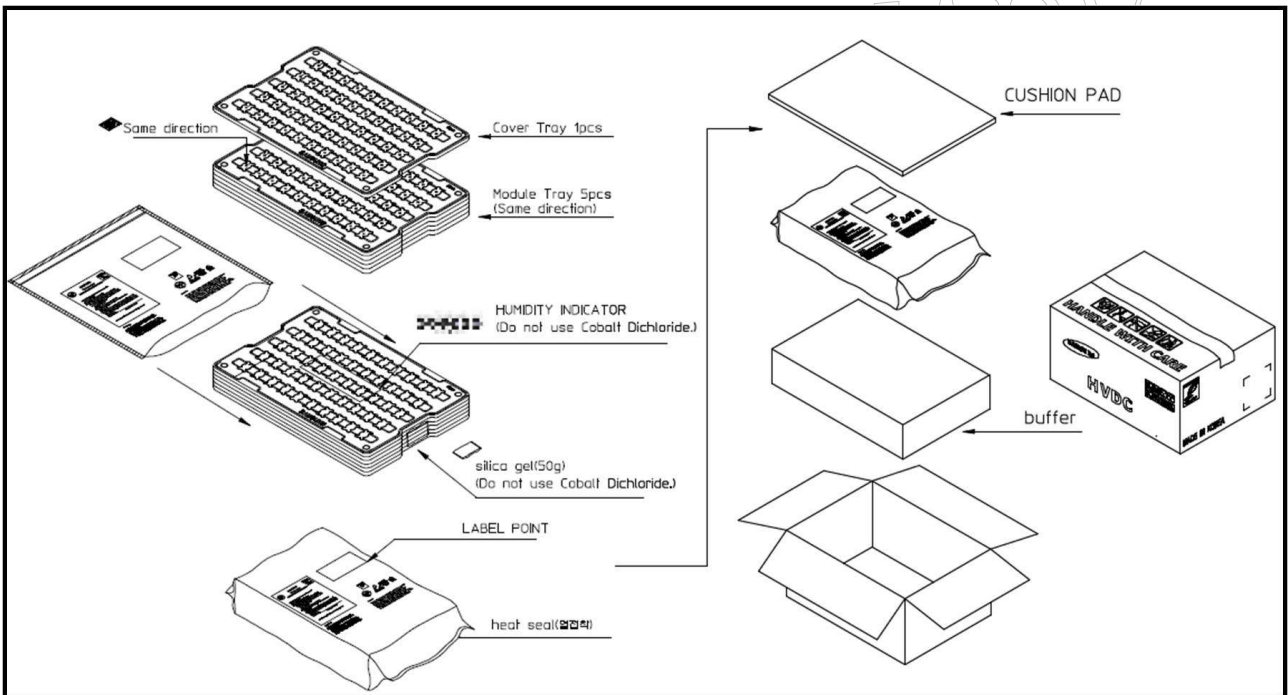

11. Aluminum Packing Bag

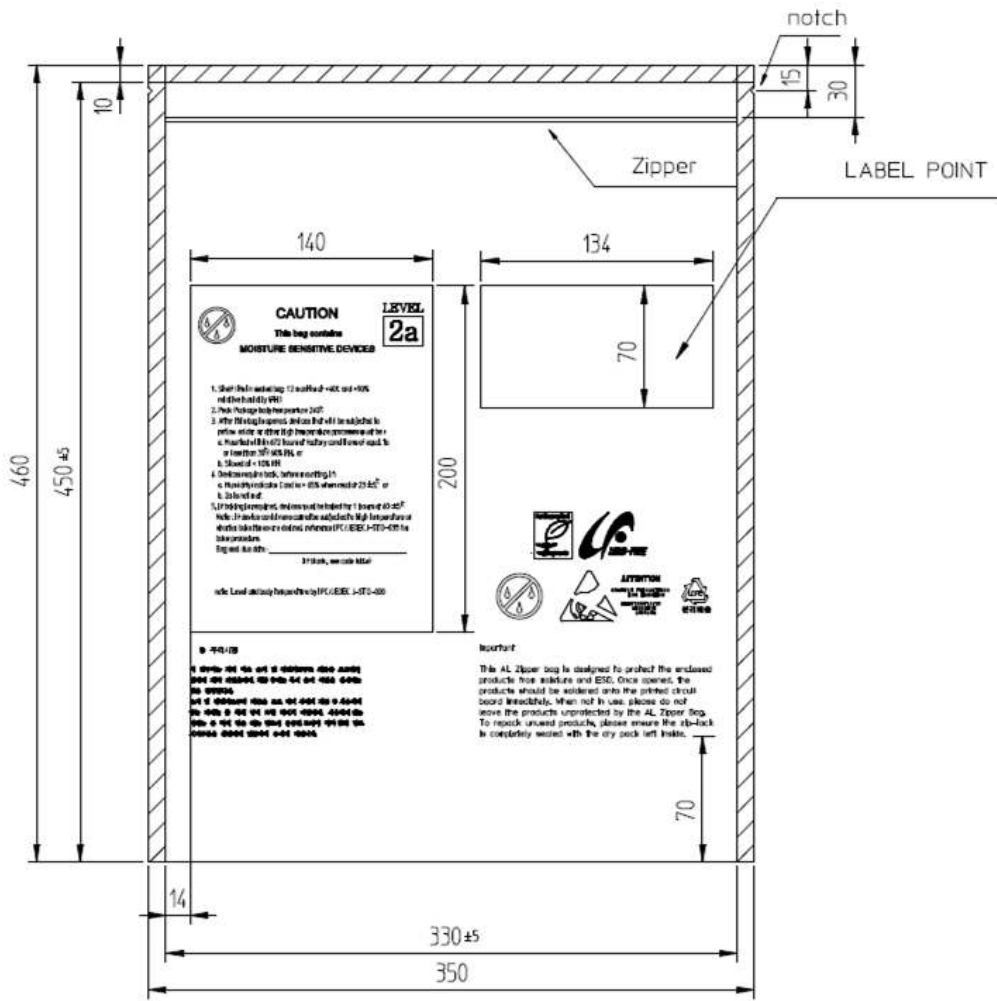

Silica gel & Humidity Indicator Card in Aluminum Bag



12. Precaution for use

- 1) For overcurrent-protection, customers are recommended to apply resistors connected in series with the LEDs to mitigate sudden change of the forward current caused by shift of the forward voltage.
- 2) This device should not be used in any type of fluid such as water, oil, organic solvent, etc. When cleaning is required, IPA is recommended as cleaning agent. Solvent-based cleaning agent such as Zestron^(R) may damage the silicone resins used in the device.
- 3) When the device is in operation, the forward current should be carefully determined considering the maximum ambient temperature and the corresponding junction temperature.
- 4) LEDs must be stored in a clean environment. If the LEDs are to be stored for 3 months or more after being shipped from Samsung LED, they should be packed with a nitrogen-filled container.
(Shelf life of sealed bags: 12 months, temp. 0~40°C, 0~90%RH)
- 5) After storage bag is open, device subject to soldering, solder reflow, or other high temperature processes must be:
 - a. Mounted within 672 hours (28 days) at an assembly line with a condition of no more than 30°C/60%RH.
 - b. Stored at <10% RH.
- 6) Repack unused Products with anti-moisture packing, fold to close any opening and then store in a dry place.
- 7) Devices require baking before mounting, if humidity card reading reaches 65% at 23±5°C.
- 8) Devices must be baked for 1hours at 60±5°C, if baking is required.
- 9) The LEDs are sensitive to the static electricity and surge current. It is recommended to use a wrist band or anti-electrostatic glove when handling the LEDs.
If voltage exceeding the absolute maximum rating is applied to LEDs, it may cause damage or even destruction to LED devices.
Damaged LEDs may show some unusual characteristics such as increase in leakage current, lowered turn-on voltage, or abnormal lighting of LEDs at low current.

